

MC 310 K12

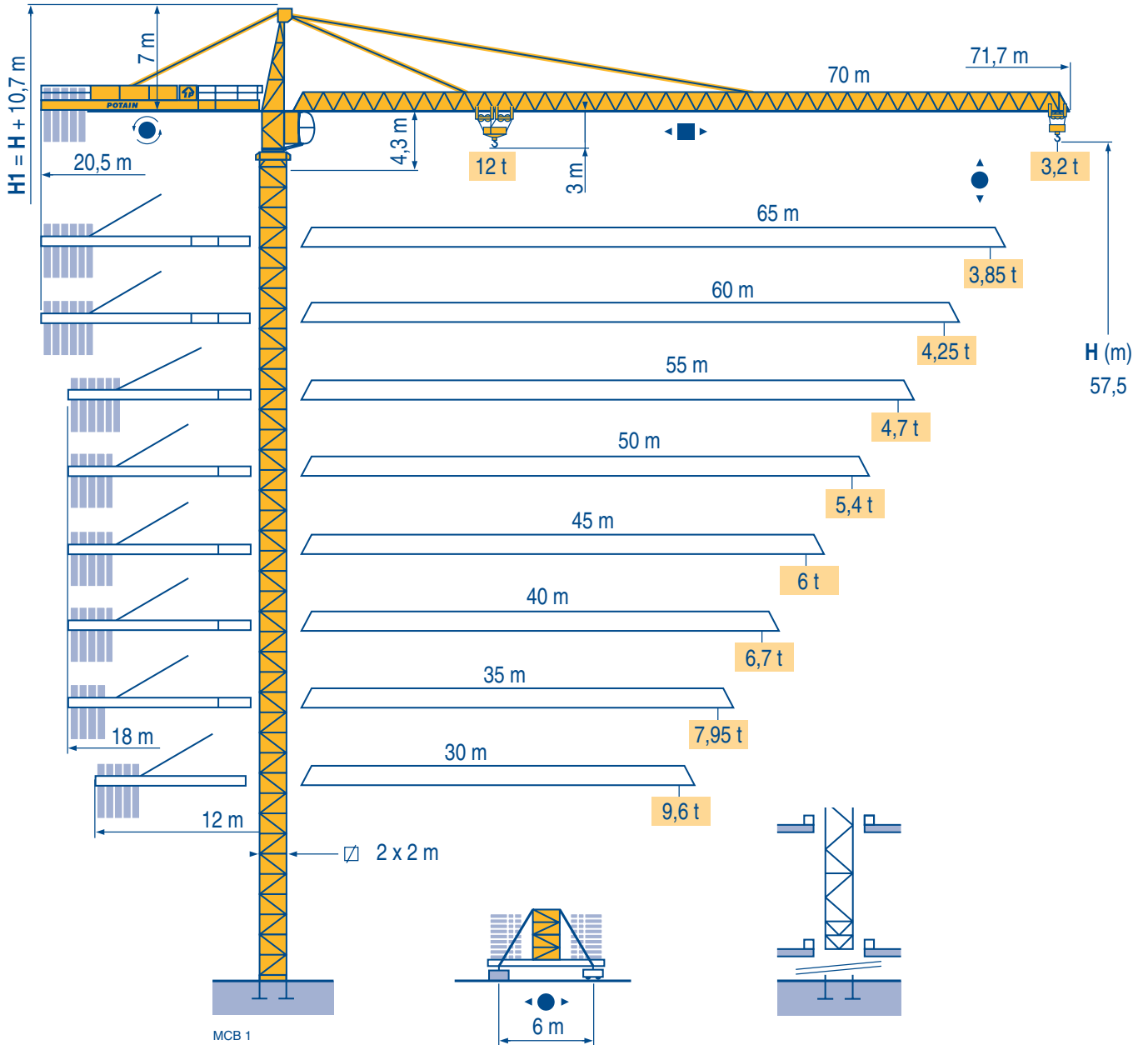

TOPKIT

Masts / Reactions

□ 2 m
 ▧ 30 m ⇒ 70 m

MCB 1

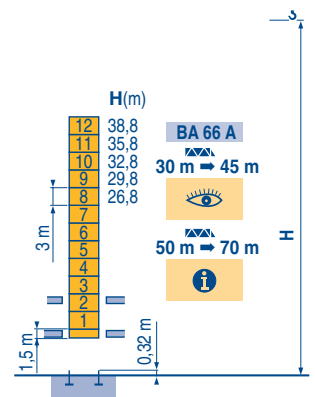
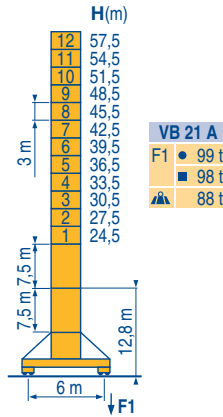
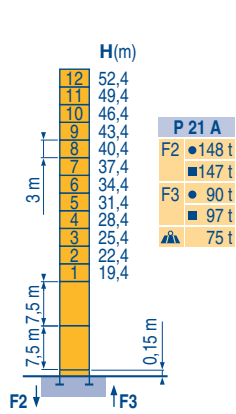

Climbing crane

MCB 1

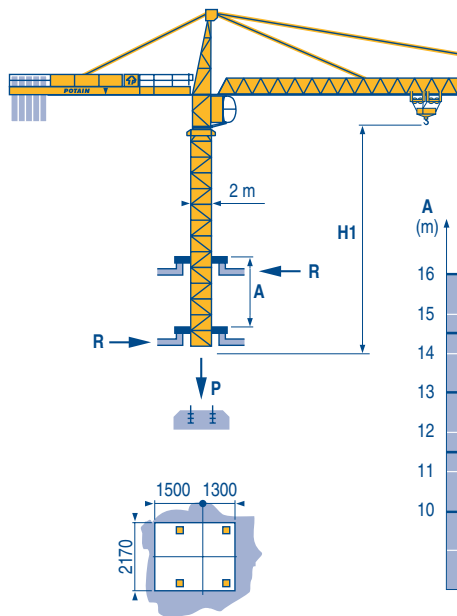

BA 66 A

30 m ⇒ 45 m

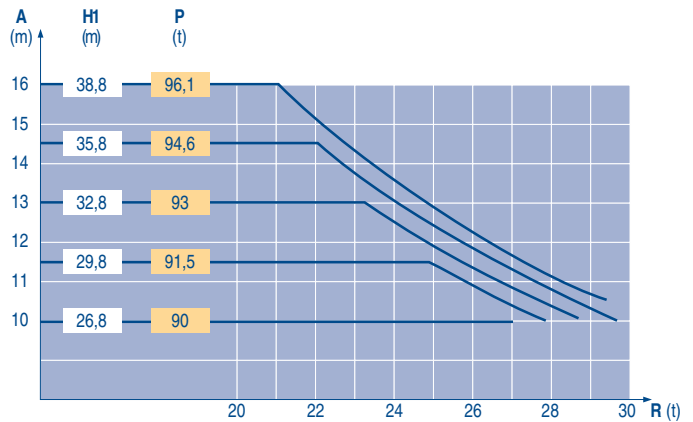

TOPKIT
MC 310 K12

GB

- Reactions in service
- Reactions out of service
- Without load, ballast (or transport axles), with maximum jib and maximum height.
- Consult us
- See climbing crane

Load diagrams

MCB 1

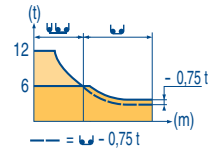
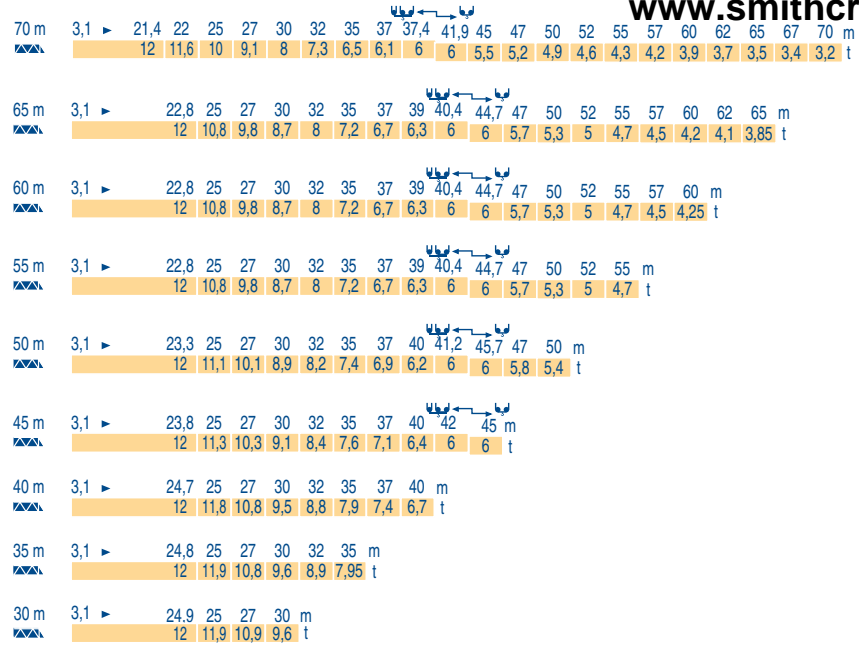

Counter-jib ballast

MCB 1

Height (m)	4 600 - 4 200 - 2 300 kg		4 200 - 700 kg	
	Length (m)	Weight (kg)	Length (m)	Weight (kg)
70 m	20,5	24 500	20,5	24 500
65 m	20,5	23 700	20,5	23 800
60 m	20,5	21 800	20,5	21 700
55 m	18	24 900	18	24 500
50 m	18	22 600	18	22 400
45 m	18	19 500	18	18 900
40 m	18	17 200	18	16 800
35 m	18	14 900	18	14 000
30 m	12	20 700	12	20 300

Base ballast

MCB 1

Width (m)	Model	H (m)	57,5	54,5	51,5	48,5	45,5	42,5	39,5	36,5	33,5	30,5	27,5	24,5	21,5
2 m	VB 21 A	(t)	84	72	72	72	72	72	72	60	60	60	60	60	60

Anchorage

MCB 1

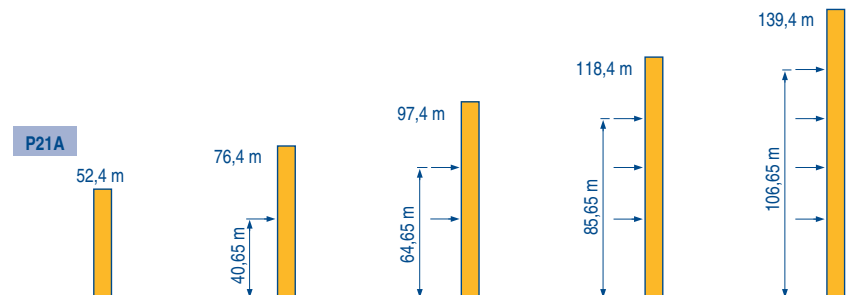

TOPKIT MC 310 K12





GB





- A Distance between collars
- H1 Crane height
- P Crane weight (in service)
- R Horizontal reaction

Mechanisms

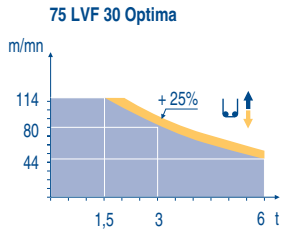
MCB 2

		↕ ↑				↕ ↑				hp	kW		
↕	75 LVF 30 Optima	m/min	0	→	44 → 56 → 80 → 114	0	→	22 → 28 → 40 → 57	75	55	570 m		
		t	6		4,5 3 1,5	12		9 6 3					
↔	6 D3 V4	m/min	15 - 50 (12 t) 100 (6 t)								7,4	5,4	
↻	RVF 162 Optima	rpm	0 → 0,7								2 x 7,5	2 x 5,5	
↔	VB 20A VB 21A	RT 544 A1 2V R ≥ 13 m	13,5 - 27								4 x 7	4 x 5,2	
CEI 38  IEC 38		kVA											
400 V (+6% -10%) 50 Hz		75 LVF : 100 kVA				2000/14							



-  **GB** Hoisting
-  Trolleying
-  Slewing
-  Travelling
-  In compliance with the EEC Instructions on noise level

 This commercial document is not legally binding.
For any technical information, please refer to the corresponding instructions.

Manitowoc
Crane CARE

Manitowoc
Crane Group



Manitowoc Crane Group Asia Pte Ltd
Manitowoc Crane Group
26 Benoi Road
Singapore 629898
Tel: 65-6861 7133
Fax: (Admin/ Sales) : 65-6862 4040
Fax: (Service/ Parts) : 65-6862 4142
www.manitowoccrane.com

Americas
Tel: +1 920 683 6322
Tel: +1 717 597 8121

Europe - Middle East - Africa
Tel : +(33) 4 72 81 50 00
Tel : +(44) 191 565 6281

Asia - Pacific
Tel: +(65) 6861 7133
Fax: +(65) 6862 4142

www.manitowoccrane.com



www.smithcranes.co.nz

TOPKIT MC 310 K12

Réf. 2004 45 MCB 1

Copyright.Reproduction interdite © POTAIN 2004

Réalisation Sedoc